



  
**DAKOTA**<sup>TM</sup>  
CLOSETS

**MENARDS**<sup>®</sup>

# WHY DAKOTA?

## Flexible Design

- Customize your closet with what you need today and adjust it as life evolves

## DIY Installation

- Components are easy to install with just a screwdriver

## Affordable Storage Solution

- Design a high-end, built-in wooden storage solution at a great price

# ENDLESS POSSIBILITIES

Organizing closets, pantries, offices, play rooms, and more, Dakota Closets™ offers functional, stylish storage solutions for every room in your home.



Reach-In Closet

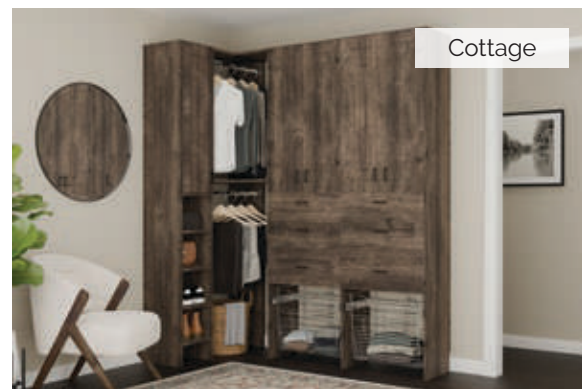

Walk-In Closet

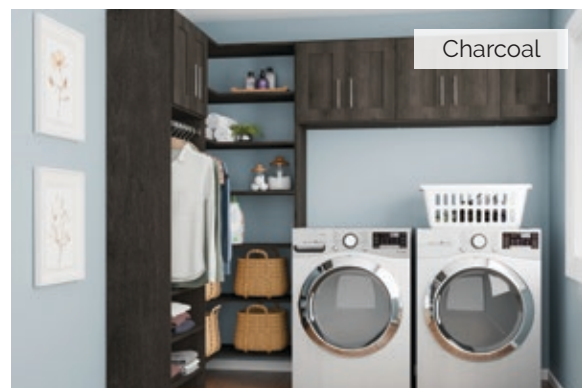

Laundry Room



Pantry

# GET STARTED TODAY!

## 1. Off The Shelf

Know exactly what you want? Simply pick the pieces and go.

## 2. Design With ÜCRĒATĒ®

Choose from our most popular configurations and design your storage in your own space.

[DakotaClosets.com/UCreate](https://DakotaClosets.com/UCreate)

## 3. Pre-Designed

Need inspiration? Browse our wide variety of closet designs to get the ideas rolling.

[DakotaClosets.com/PreDesigned](https://DakotaClosets.com/PreDesigned)



# CHOOSE YOUR FINISH

## Shaker



White



Cottage



Charcoal

## Slab



Coastal Oak\*  
\*Special Order

# DESIGN WITH ÜCRĒATĒ® [DakotaClosets.com/UCreate](https://DakotaClosets.com/UCreate)

Take the guesswork out of your project with the ÜCrëatë® Closet Planner. See your closet before you buy, stay on budget, and get a complete materials list and floor plan to keep you organized.

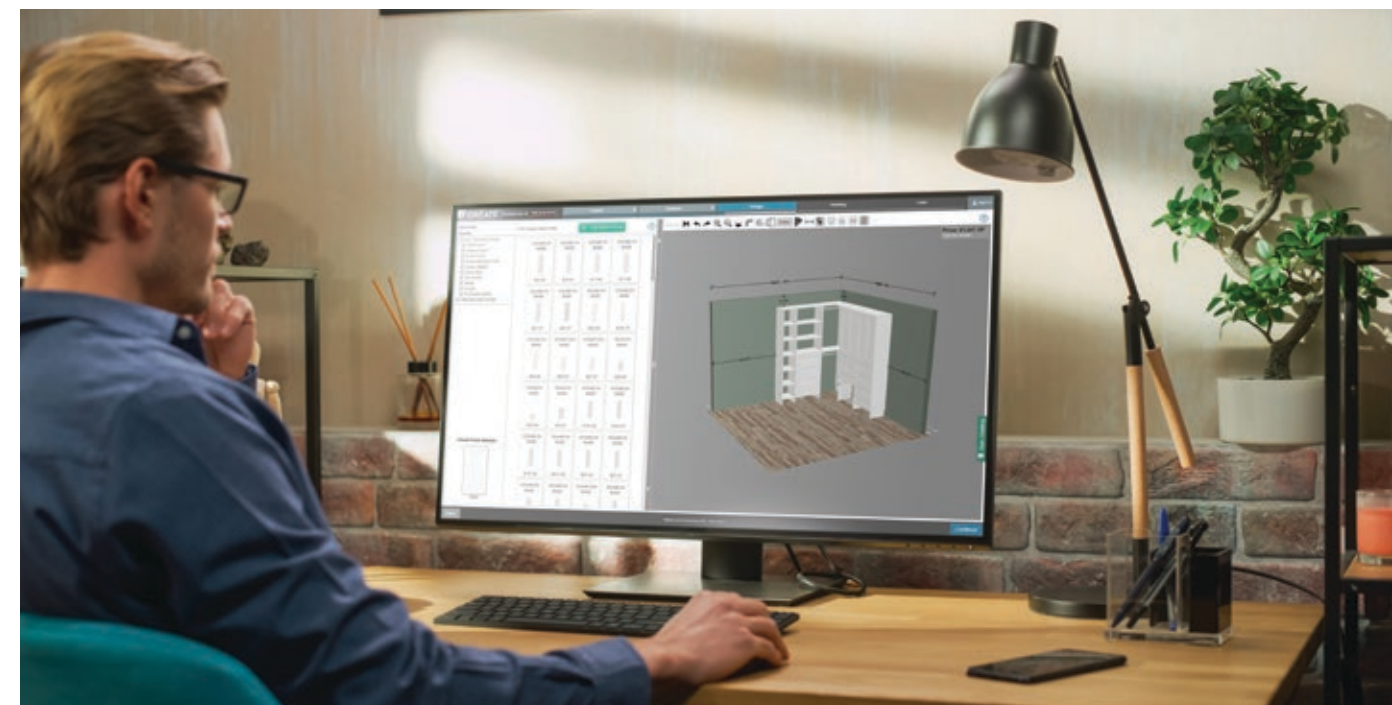

# WALK-IN & REACH-IN CLOSETS



Mount your closet on the wall to easily store hampers, luggage, and shoes beneath



Full access corners maximize storage with no dead space



Use 12" shelves to organize smaller items, shoes, and more



Extendable rods allow for custom widths with no cuts and can be mounted to a wall or upright



# STORAGE AROUND THE HOME



Transform your office into a clutter-free, efficient workspace



Adjustable shelves keep pantry items visible, organized, and easy-to-reach



Not enough closet space? A wardrobe is a great solution to neatly store your clothes and accessories



Keep your entryway tidy by storing coats and accessories neatly in the closet



Modular design allows you to update your kids' playroom as they grow and keep toys, crafts, and books off the floor



# FEATURES & ACCESSORIES



Matching doors and drawers for concealed storage options that look clean and tidy



Pre-drilled uprights make adjusting the height of shelves, wardrobe rods, and accessories fast and easy



A touch of luxury with soft close doors and drawers



Maximize the corners with hanging or shelving sections



Baskets come in two heights: 7"H and 18"H, a perfect addition to any design



The pull-out tie rack is a great way to keep your ties organized and looking sharp



For easy access and convenience store slacks, trousers, and jeans on the pull-out pants rack



Wardrobe rods come in 24" and 36" widths as well as two extendable sizes: 11-5/8" — 20" and 20" — 36"



The pull-out valet rod comes in a chrome finish and has a replaceable knob to allow for personalization



Add a pull-out belt rack to have a simple storage solution for up to nine belts

# PLAN YOUR SPACE



## How To Plan Your Space

Below are some general vertical spacing recommendations for different articles of clothing.

- 1 Plan approximately 35" for shirts
- 2 Short dresses need approximately 51-1/2"
- 3 Garments such as long coats or dresses need up to 75"
- 4 Plan approximately 24" for hanging pants on a pants rack

# INSTALLATION METHODS



## Floor Standing

### More Storage Space

- Ability to use 86-1/2" uprights offers more room for shelves, drawers, and accessories

### Easy Installation

- Install with one L-Bracket atop each section, fastened to a stud

### Built-In Look

- Pre-notched uprights fit around baseboard moulding up to 5" H



## Wall Mounted

### Space Saving Design

- Maximizes floor space
- Easy to clean underneath
- Storage for large items below

### Easy Installation

- Hung on a hang track with one hang bracket per upright
- Easy leveling

### Versatile For Any Room

- Mount it at any height
- Works around moulding, vents, and other obstacles



Installation Library  
[DakotaClosets.com/Lit](https://DakotaClosets.com/Lit)

# BUILD YOUR CLOSET

## Uprights

- 21"H
- 41"H
- 61-1/4"H
- 86-1/2"H\*

\*Floor Standing Only

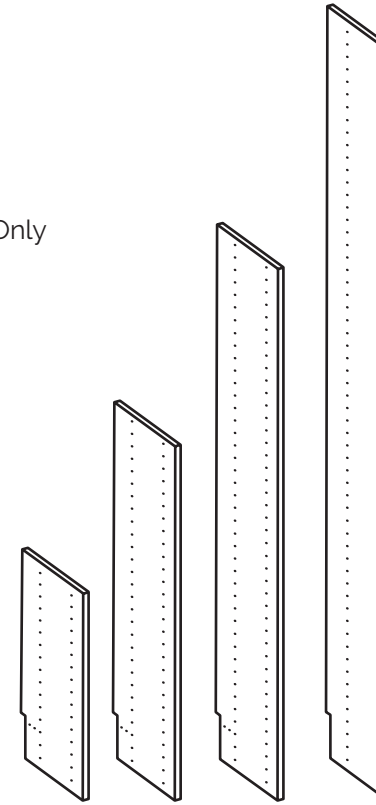

## Shelves (2 pk)

- 12"W\*
- 24"W
- 36"W
- Cut to fit

\*Actual Size is 11 5/8"

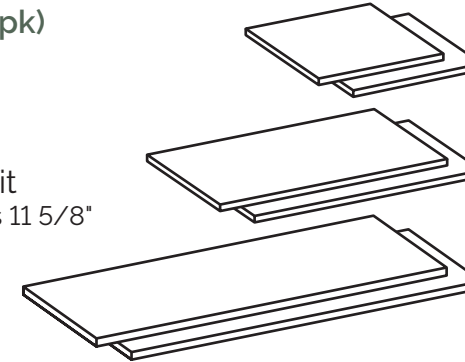

## Doors

- 12"W x 20"H
- 12"W x 40"H
- 18"W x 20"H\*
- 18"W x 40"H\*

\*Special Order

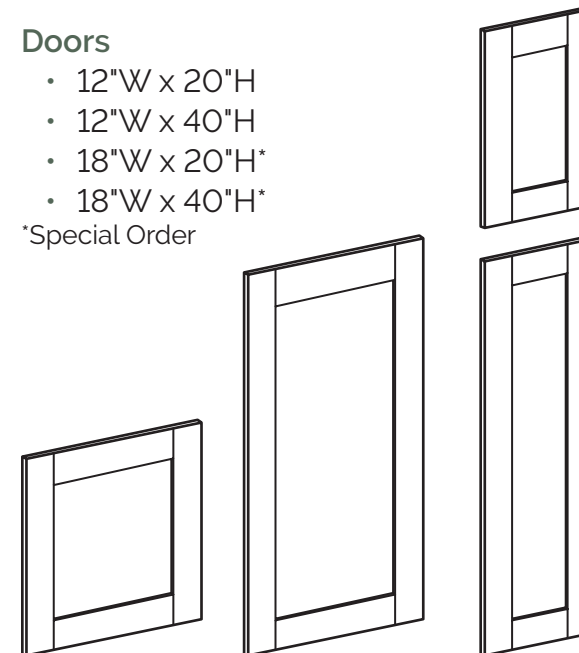

## Drawers

- 12"W x 5"H\*
- 12"W x 10"H\*
- 24"W x 5"H
- 24"W x 10"H
- 36"W x 5"H\*
- 36"W x 10"H\*

\*Special Order

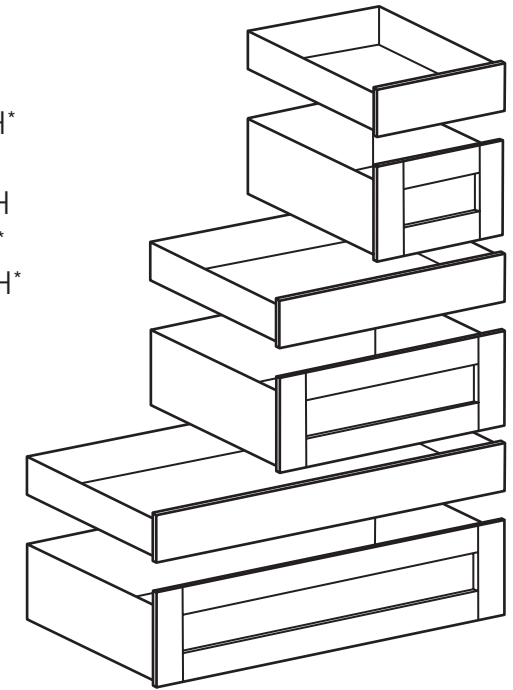

## Wardrobe Rods

- Extendable 11-5/8" - 20"W
- Extendable 20" - 36"W
- 24"W (2 pk)
- 36"W (2 pk)

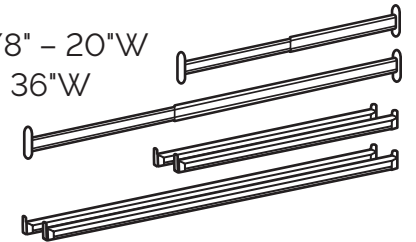

## Baskets

- 24"W x 7"H
- 24"W x 18"H

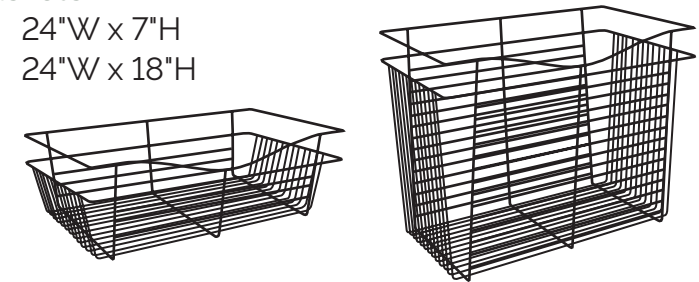

## Pants Rack

- 24"W x 14"D

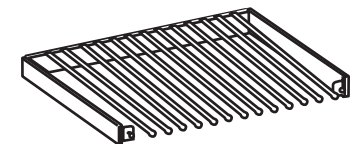

## Accessories

- Tie Rack
- Belt Rack
- Valet Rod

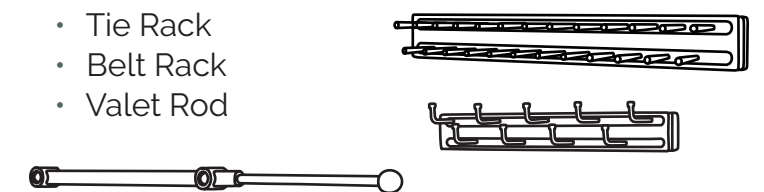

\*All Coastal Oak Items Are Special Order

# Ü CRÉATÉ®

CLOSET PLANNER

[DakotaClosets.com/UCreate](https://DakotaClosets.com/UCreate)



## 3D Design Your Space! [DakotaClosets.com/UCreate](https://DakotaClosets.com/UCreate)

Design your closet layout today from the comfort of your home! As you design ÜCréatë® automatically estimates the price and makes a shopping list for you. Save your designs with your Menards.com account, this way you can come and go as you please. Purchase your Dakota™ Closets directly online or by visiting your local **MENARDS®**

- Pricing as you design
- Save your design and edit anytime
- Floor plan and elevation views
- Chat available for assistance
- Pick up in store or get it delivered

**DAKOTA**™  
CLOSETS

[DakotaClosets.com](https://DakotaClosets.com)